



VSX™ 26e and VSX™ 48e Digital Loudspeaker Processors

Operating
Manual





FCC/ICES Compliancy Statement

This device complies with Part 15 of the FCC rules and Industry Canada license-exempt RSS Standard(s). Operation is subject to the following two conditions: (1) this device may not cause harmful interference, and (2) this device must accept any interference received, that may cause undesired operation.

Le présent appareil est conforme aux CNR d'Industrie Canada applicables aux appareils radio exempts de licence. L'exploitation est autorisée aux deux conditions suivantes: (1) l'appareil ne doit pas produire de brouillage, et (2) l'utilisateur de l'appareil doit accepter tout brouillage radioélectrique subi, même si le brouillage est susceptible d'en compromettre le fonctionnement.

Warning: Changes or modifications to the equipment not approved by Peavey Electronics Corp. can void the user's authority to use the equipment.

Note – This equipment has been tested and found to comply with the limits for a Class B digital device, pursuant to Part 15 of the FCC Rules. These limits are designed to provide reasonable protection against harmful interference in a residential installation. This equipment generates, uses, and can radiate radio frequency energy and, if not installed and used in accordance with the instructions, may cause harmful interference to radio communications. However, there is no guarantee that interference will not occur in a particular installation. If this equipment does cause harmful interference to radio or television reception, which can be determined by turning the equipment off and on, the user is encouraged to try and correct the interference by one or more of the following measures.

- Reorient or relocate the receiving antenna.
- Increase the separation between the equipment and receiver.
- Connect the equipment into an outlet on a circuit different from that to which the receiver is connected.
- Consult the dealer or an experienced radio/TV technician for help.

Caution

The equipment complies with FCC radiation exposure limits set forth for an uncontrolled environment.



VSX™ 26e and VSX™ 48e

Digital Loudspeaker Processors

The VSXe processors are DSP-based, loudspeaker management systems that boast a 96kHz sample rate and a floating point DSP processor for quiet accurate filter response. The crossover filters are fully adjustable and any input can be routed to any output. The VSX® Editor Program for PC allows complete remote setup and operation via the front panel USB port or by the rear panel Ethernet network connection. Files can also be saved and loaded using this interface software.

This manual covers both the VSX 26e and VSX 48e DSP processors. The units are essentially identical except for the number of inputs and outputs. Please read this guide carefully to ensure your personal safety as well as the safety of your equipment.

Features

- Balanced Inputs: VSX 26e 2, VSX 48e 4
- Balanced Outputs: VSX 26e 6, VSX 48e 8
- 96 kHz Sample rate
- 24 bit Delta-Sigma A/D and D/A converters
- Dynamic range input to output greater than 109 dB (A-weighted) or 107 dB (unweighted)
- Every input features Gain, Mute, HP and LP filters, 8 bands of PEQ, polarity and Delay (680 mS),
- Every output features: 9 bands of PEQ, gain, compressor/limiter, polarity, Delay (680 mS), mute, and crossover/band-pass filters
- EQ filter types include: PEQ, Low-Shelf, Hi-Shelf, Low-Pass, High-Pass, All-Pass1 and All-Pass2.
- Crossover/Band-pass filters feature Butterworth, Bessel or Linkwitz-Riley alignments from 1st order (6 dB/Oct) to 8th order (48 dB/Oct).
- Signal generator (sine, white noise, pink noise).
- Channels can be linked for simplified stereo operation.
- 5 segment LED meters on each input
- 5 segment LED meters with limit indication on each output
- 2 XLR balanced inputs and 6 XLR balanced outputs VSXe 26
- 4 XLR balanced inputs and 8 XLR balanced outputs VSXe 48
- Maximum input and output level +20 dBu, XLR balanced inputs and outputs.
- Frequency response 20 Hz to 20 kHz +0, -1 dB
- THD+N < 0.01% at 1 kHz.
- Security lock
- USB B port for setup and control
- Ethernet port for setup and control.
- Dimensions (HxWxD) 1.75" x 19" x 8" / 45mm x 480mm x 20.5mm
- Weight 5.2 lbs /2.88 kg
- PC Editor Programs allow complete remote setup and operation via USB or Ethernet.

NOTE: The VSX processors can be setup and operated both from the front panel and from the VSX Editor running on a PC. The PC can be connected to the VSX via USB or Ethernet.

Front Panel

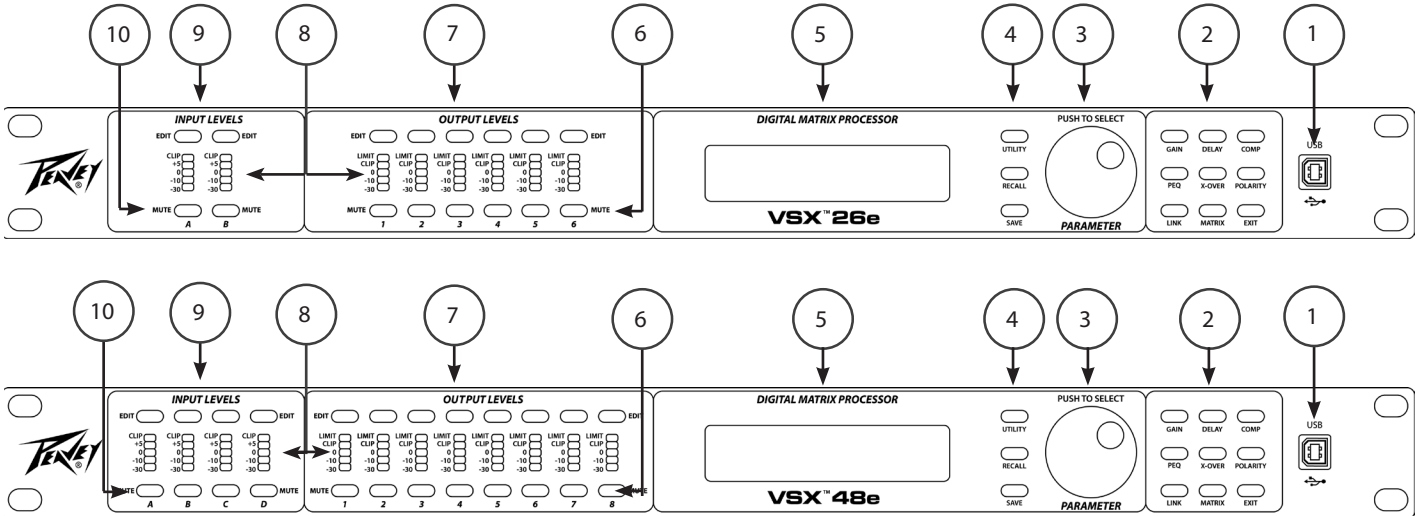

(1) USB port

The USB "B" connector is used to connect a host computer for editing and control using the VSX Editor Program.

(2) Process Function Buttons

The process-function buttons are used to select a process for editing. Lighted buttons illuminate to indicate they are available selections. The available functions are different when an input, output or system mode (no input or output selected) for editing.

GAIN: Used to access channel gain controls

Delay: Used to access channel Delay controls

COMP: Available only for output editing, used to access channel compressor/limiter controls.

PEQ: Used to access channel equalization controls

Xover: Used to access the low-pass filter and high-pass filter controls.

POLARITY: Used to access channel polarity normal or invert controls

MATRIX: Available only for output editing, used to route inputs to outputs.

EXIT: Exit channel editing.

(3) Parameter Knob

The parameter knob is used by pressing and rotating to edit processing parameters.

(4) System Function Buttons

Utility: Utility functions include setting Unit ID#, IP address, Security Lock and password, input signal or signal generator, copy channel and Delay units.

Recall: Used to load saved system presets.

Save: Used to save system presets.

(5) **LCD Display**

Used in conjunction with the front panel controls to edit processing parameters.

(6) **Output Mute Buttons**

Pressing the mute button alternately mutes and un-mutes the corresponding output. The button lights red when muted.

(7) **Output Edit Buttons**

Press this button to begin editing processes for the selected output. The specific process to edit can be selected using the process-function buttons on the right.

(8) **Input/Output Monitoring:**

Input: The 5 segment LED meters indicate the input signal level with the top Clip LED illuminating before the onset of clipping. Although you will want to avoid clipping, you will achieve best performance if the 0 LED lights frequently during loud passages.

Output: The top LED illuminates to indicate the signal has reached the threshold set in the compressor/limiter and that gain reduction is occurring. The bottom 4 LEDs form the output level meters indicating signal level. The Clip LED illuminates before the onset of clipping. Although you will want to avoid clipping, you will achieve best performance if the 0 LED flashes frequently during loud passages.

(9) **Input Edit Buttons**

Press this button to begin editing processes for the selected input. The specific process to edit can be selected using the process-function buttons on the right.

(10) **Input Mute Buttons**

Pressing the mute button alternately mutes and un-mutes the corresponding input. The button lights red when muted.

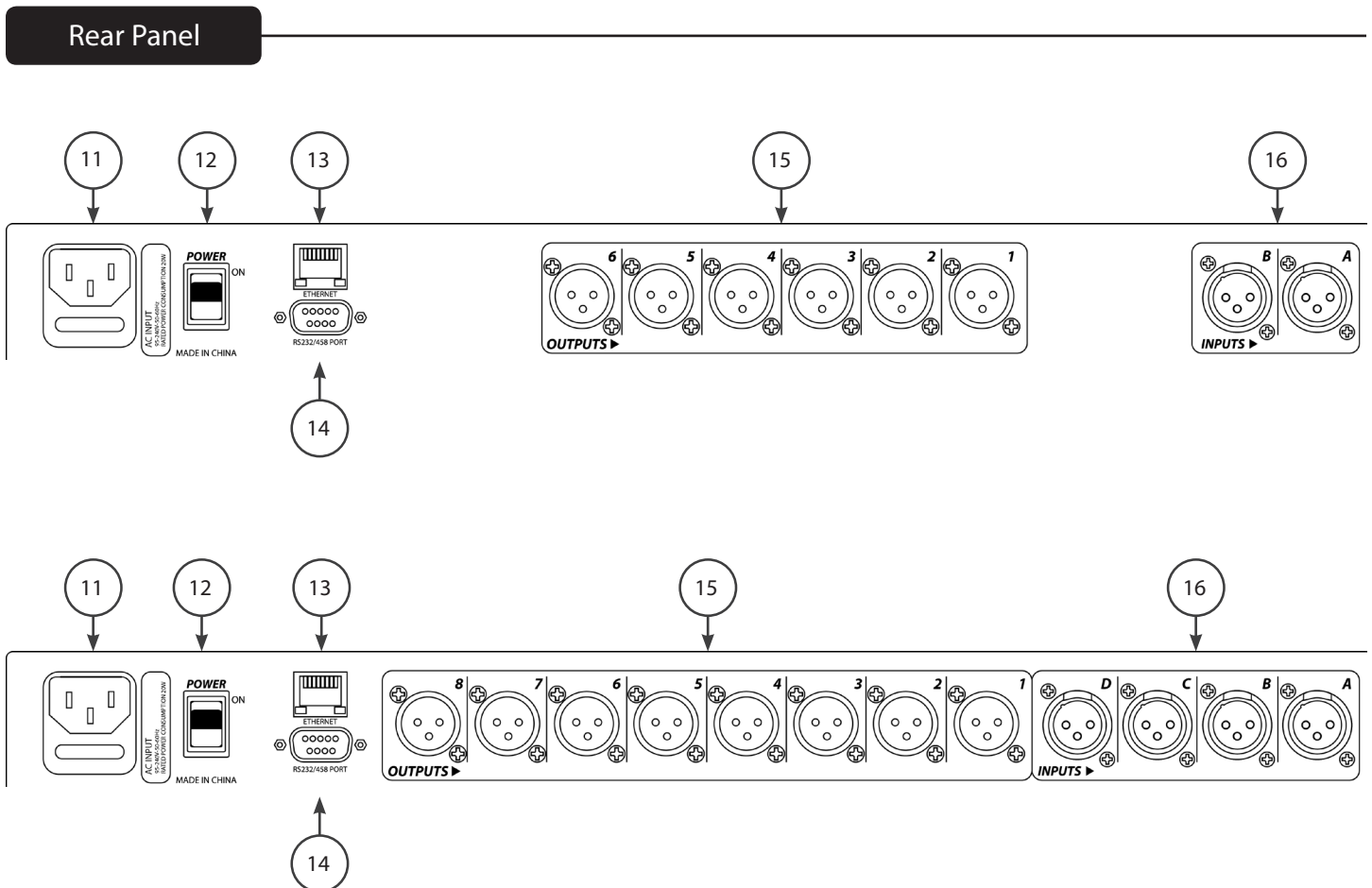



(11) IEC POWER CORD CONNECTION and Fuse Holder

This receptacle is for the IEC line cord (supplied) that provides AC power to the unit. It is very important that you ensure the unit has the proper AC line voltage supplied.

Please read this guide carefully to ensure your personal safety as well as the safety of your equipment. Never break off the ground pin on any equipment. It is provided for your safety. If the outlet used does not have a ground pin, a suitable grounding adapter should be used and the third wire should be grounded properly. To prevent the risk of shock or fire hazard, always be sure that the mixer and all other associated equipment are properly grounded.



Caution: For 195 to 240 VAC operation, a “F2AL 250V” fuse rated at 2 amps should be used.

(12) ON-OFF SWITCH

This rocker switch supplies AC power to the unit when switched to the ON position. The ON position is with the top side of the switch pushed “in” or nearly flush with the rear panel.



(13) Ethernet Control Interface

Ethernet port for control of the VSX using the graphical user interface.

(14) D sub 9 connector

Connection for RS232 and RS485 serial control.

(15) OUTPUTS

XLR balanced outputs 1-6 or 1-8.

(16) INPUTS

XLR balanced inputs A and B or A, B, C and C.

Operation

Operating the VSX processors from the front panel is made simple by a wide array of buttons and a simple intuitive interface.



VSX 48e
DSP Processor V1.0

Opening screen shows product name and firmware version.



VSX 48e
003 Concert Preset

After a brief time out, the currently active preset is displayed.

Global Functions: Utility, Recall and Save

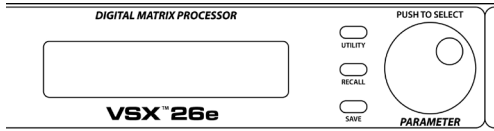

Pressing the utility button opens the screens for system wide settings. Each press of the utility button advances to the next screen in the sequence. You can press the "Exit" button at any time to return to the main screen.

Device ID #: (Utility Button)

ID Number Select
ID : 1

The ID number of the unit can be set in this screen. The ID is used with the Editor program to identify this unit when multiple units are connected. Each unit must have a unique identifier. It is most important when units are connected together using the RS 485 serial interface. See the section on serial communication for more details.

Ethernet Address: (Utility Button)

Manual IP Setting
192.168. 1.101

Set the Ethernet, IP address here for connection to the Editor program using the Ethernet port. Make sure to note the new address if you edit address!

Security Lock: (Utility Button)

Unit Lock
Password [1234]

Once on this screen, the parameter knob is used to set the password. Press to advance and rotate to change each digit. A "Y" or "N" will appear allowing to engage the lock "Y" or turn it off "N".

Input Source Select: (Utility Button)

Input Source Select
ANALOG INPUT

During normal operation, the analog inputs on the rear of the VSX are routed to the outputs. However, the VSX has an internal signal generator that can be used for setup and testing. Rotating the parameter knob allows you to select Analog Input, Pink Noise, White Noise or a Sine-Wave as the input source for all inputs. The new selection will blink on the screen. Press the Parameter knob to select. You may wish to mute outputs that you do not wish to receive the signal from the generator. Analog input must be selected for those inputs to function.

Copy Settings: (Utility Button)



Copy Channel Select
InA -> InB

Settings can easily be copied from one input channel to another input or from one output to another. Rotate the parameter encoder to select the parameter.

Delay Units: (Utility Button)



Delay Units Select
MS

The units used to set delays can be selected on this screen. The options are milli-Seconds (mS), meters (m) or feet (ft)

Load: (Recall Button)



Load Preset
003 Concert Preset

Rotate the Parameter knob to select the desired preset number then press to load.

Save: (Save Button)



Store Preset
003 Concert Preset

Select the desired user storage location using the parameter knob then Press. Enter a name for the preset and then press the parameter knob again when the "Y" appears to complete the save.

Input/Output Parameters

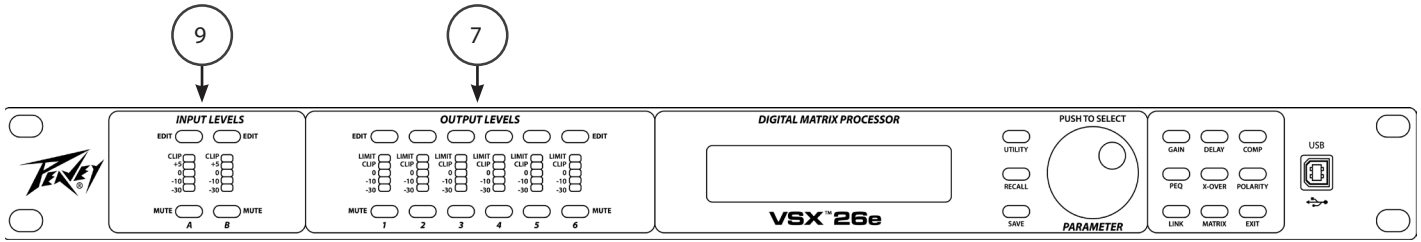

The next section of controls are used to make adjustments to a particular input or output.

Begin by pressing the "EDIT" button (7 and 9) for the channel you wish to adjust. The edit function buttons at the right side of the front panel that apply to the channel selection will light. The function selected will blink.

Input Edit functions: Gain, PEQ, Link, Delay, X-Over and Polarity.

Output Edit functions: Gain, PEQ, Link, Delay, X-Over, Matrix, Comp and Polarity.

While editing, you can select another function or another channel by pressing the appropriate button.

Press Exit to return to the main screen.

Gain



The input and output gain can be adjusted in a range of -60 dB to +12 dB in 0.1 dB increments. For best operation, the gain should not be set at extreme settings (0dB is optimal). It is always best to adjust the signal level driving the VSX input so that the Yellow LED lights on louder signals. When using the crossover on an output, you may need to increase the gain to achieve sufficient signal level to drive the amplifier. If you find that you need to turn down an output very far below 0 dB, you will get quieter operation if you reduce the amplifier input level control instead.

PEQ



The input channels have 8 bands of equalization available and the outputs have 9. The EQ band is indicated in the upper left corner of the display. (Band 1 is shown above) The parameter selected for adjustment will blink on the screen. Press the parameter knob to select a parameter for editing. Rotate the knob to adjust.

F= Frequency, Q is inverse of Bandwidth. High Q equates to narrow bandwidth. G= Gain.

The EQ types available are: Peak/Dip (PEAK), Low-Shelf (L-SHLF), High-Shelf (H_SHLF), Low-Pass (L-PASS), High-Pass (H-PASS), All-Pass 1 (A-PAS1), All-Pass 2 (A-PAS2)

"On" is active and "By"= Bypass.

Link



Many times, in particular for stereo signals, you may want to make the same adjust to two or more channels at the same time. Using the link function, inputs can be linked to other inputs and outputs can be linked to other outputs. The check marks on the above screen indicate linkage. When channels are linked, the edit buttons for those channels will blink simultaneously when editing.

Delay



Up to 680 milli-Seconds of delay can be added to any input or output. The delay resolution is 1 sample or 10.4 micro-Seconds.

Crossover (X-Over)

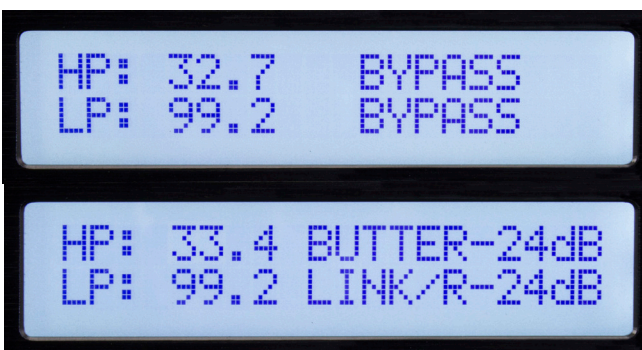

Although the button is labeled X-OVER and that is how these functions are often used, each input and output have very flexible high-pass and low-pass filters that can be configured for many applications.

To activate the filter use the parameter control to select bypass on the screen and change it to the desired filter type. There are 3 different filter alignments available, Butterworth, Bessel and Linkwitz-Riley. The filter slopes of 6 dB/Octave to 48 dB/Octave can be selected.

Matrix



```
OUT1 MATRIX SELECT
A:V B:x C:x D:x
```

The Matrix screen is only available when editing an output. This is where the inputs that drive each output are connected. The above screen shows input "A" as the signal source for output 1. If multiple inputs are selected, their signals are summed.

Compressor (COMP)



```
COMP T:+12.5 R:LIMIT
AT: 50ms RT:200ms
```

The compressor screen is only available when editing an output. The compressor parameters are: T= Threshold, R= Ratio, AT= Attack Time and RT= Release Time. The threshold is roughly equal to the limiting level in dBu. The limit LED corresponding to the output channel will light when the threshold is exceeded. The status is also displayed in the computer editor.

Polarity



```
OUT1
POLARITY 0
```

0= Normal polarity. 180= Reverse polarity.

The VSX processors can be setup and controlled using the VSX Editor which runs on a Windows computer. To control the VSX, the computer can be connected to the VSX via USB, Ethernet, RS-232 or RS-485. For most applications, USB or Ethernet will be the preferred solutions.

Connect the computer to the VSX using a USB cable connected to USB jack on the front of the unit.

When connected to the editor, front panel controls are locked out.

Connecting a computer to the VSX via Ethernet.

The VSX processors use a "Static" IP address. Setting the address of the unit and ID# is described in the utility section of the manual. The Editor must be set the matching IP address and ID# in order to connect.

An Ethernet cable can be connected directly to most computers if only one unit is being controlled. In most cases you will want to use an Ethernet router or WiFi router.

If the computer is connected before launching the VSX editor software, the software will search for connected devices. If it does not connect, check to be sure the IP address and device ID# of the unit match the settings in the editor. Also, make sure the VSX IP address is set in the network range of your computer and router. You can then click scan or click the offline Icon in the upper right corner of the screen to scan and connect.

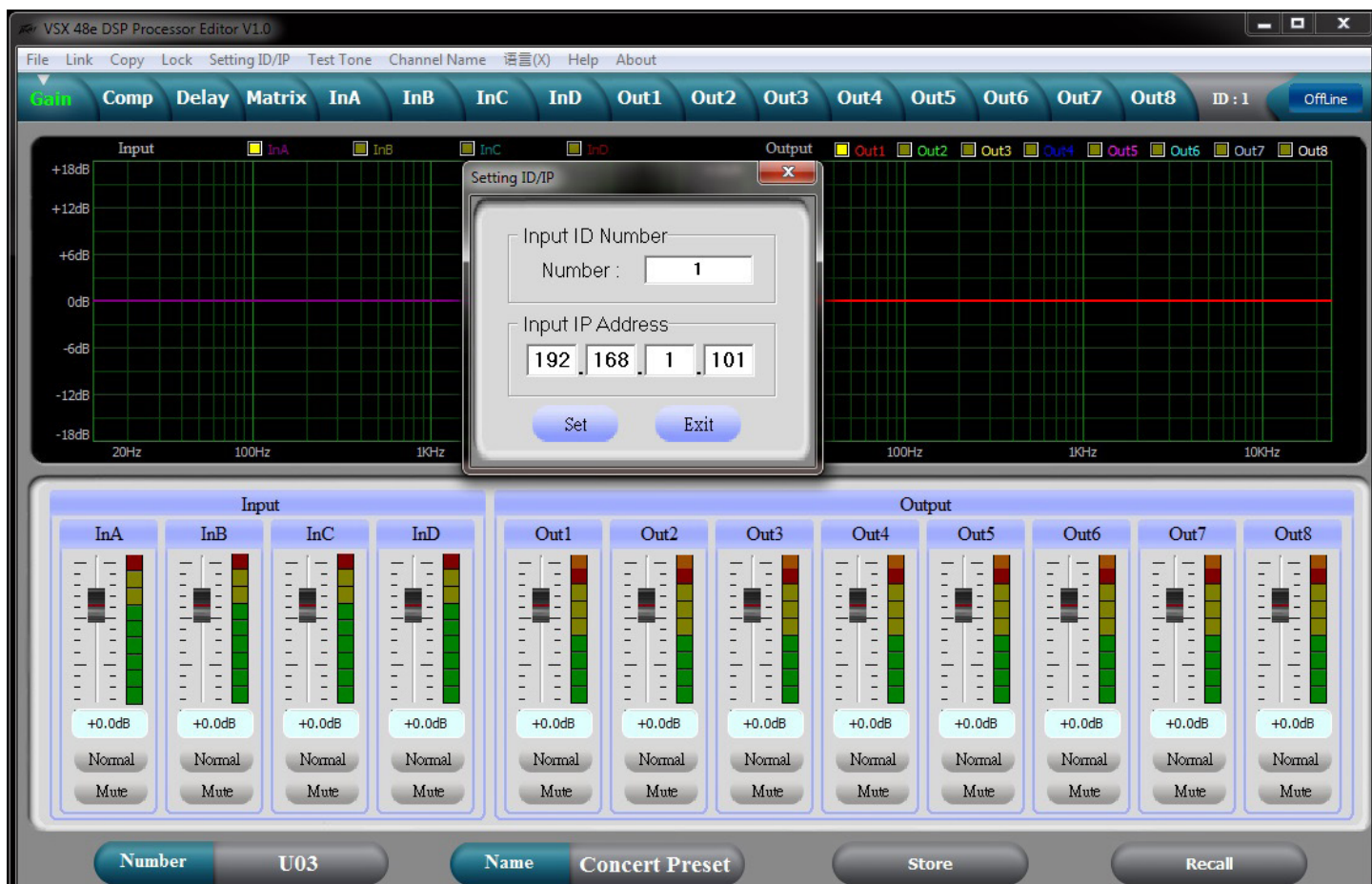

Once connected, the setting from the unit will be loaded and the icon will turn green and indicate online. Use the Tabs at the top of the screen to navigate to the desired screen.

Gain Screen

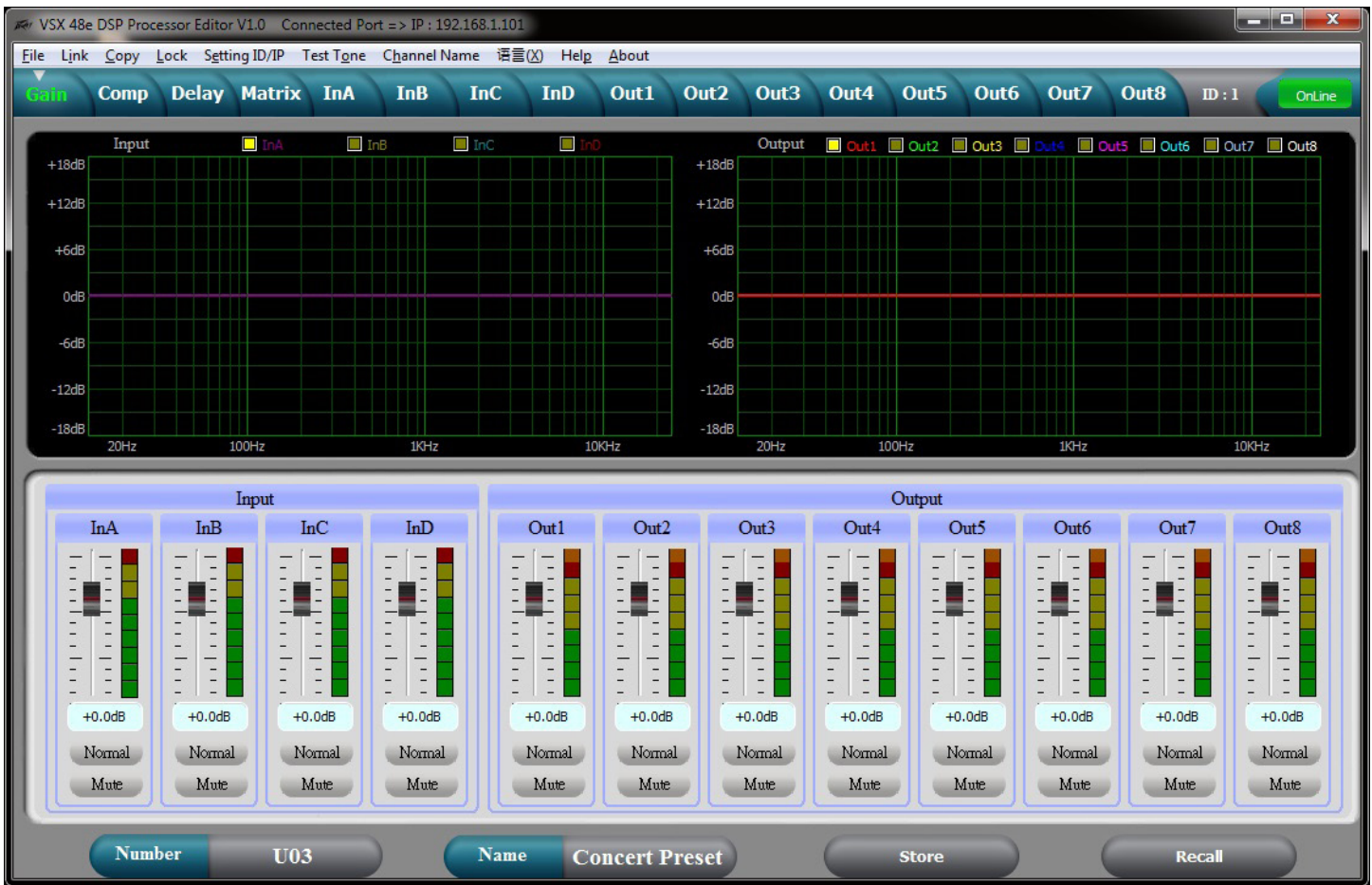

The gain screen above gives a good overview of the system. In addition to showing input and output gains, mute and polarity status, Input and output equalization curves can be displayed.

Compressor Screen

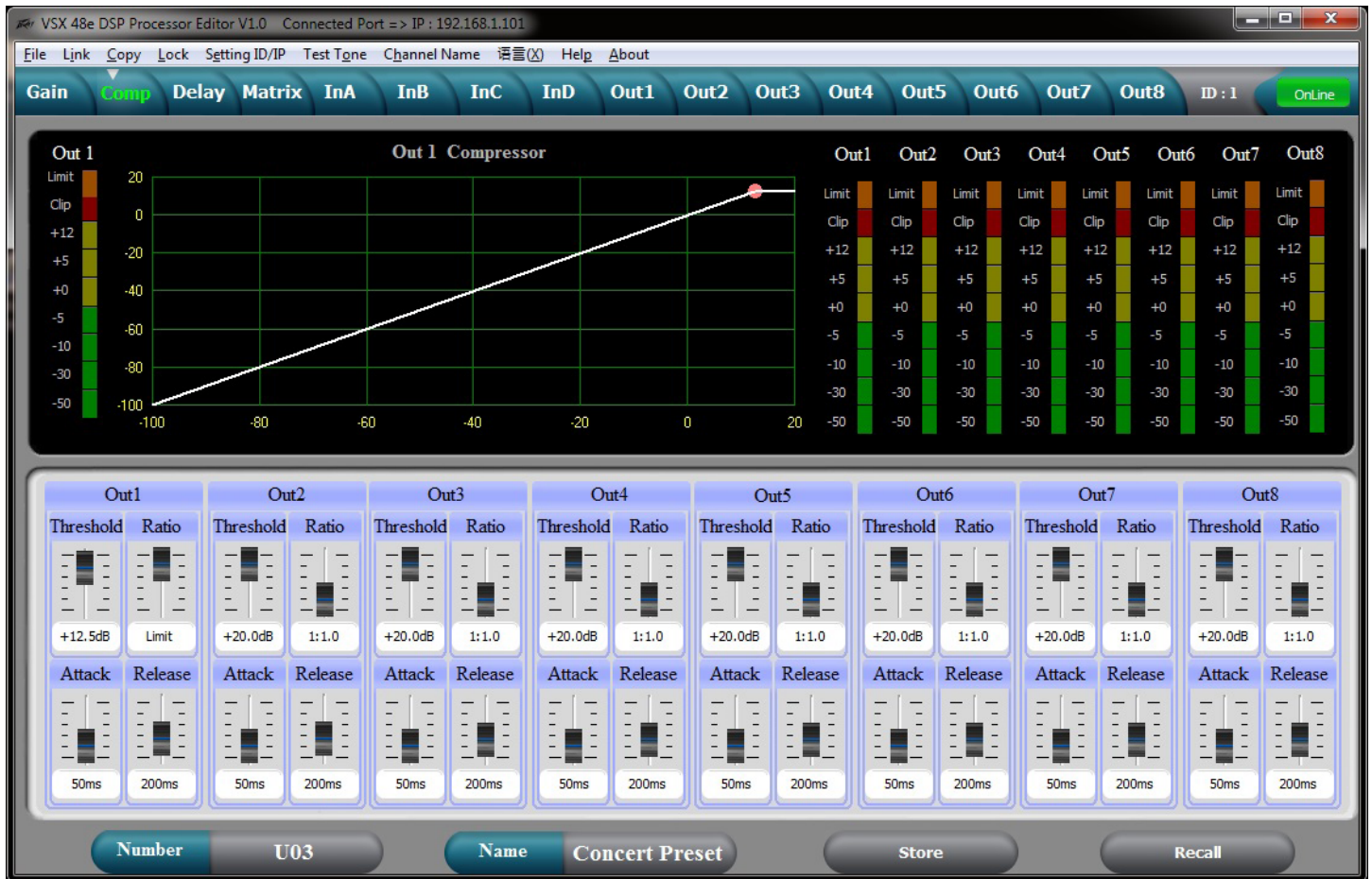

The Compressor screen displays the settings of all 8 output compressors along with signal level, and limit status. The transfer function of a selected output is also displayed.

VSX 48e DSP Processor Editor V1.0 Connected Port => IP : 192.168.1.101

File Link Copy Lock Setting ID/IP Test Tone Channel Name 语言(中) Help About

Gain Comp **Delay** Matrix InA InB InC InD Out1 Out2 Out3 Out4 Out5 Out6 Out7 Out8 ID : 1 OnLine

Input Delay

InA - 20.000 ms

InB 0.000 ms

InC 0.000 ms

InD 139.531 ms

Output Delay

Out1 2.000 ms

Out2 1.698 ms

Out3 0.000 ms

Out4 0.000 ms

Out5 0.000 ms

Out6 0.000 ms

Out7 0.000 ms

Out8 0.000 ms

Input

InA InB InC InD

20.000 ms 0.000 ms 0.000 ms 139.531 ms

Output

Out1 Out2 Out3 Out4 Out5 Out6 Out7 Out8

2.000 ms 1.698 ms 0.000 ms 0.000 ms 0.000 ms 0.000 ms 0.000 ms 0.000 ms

Unit

ms

m

ft

Number U03 Name Concert Preset Store Recall

All of the input and output delays are shown in the above screen. Delays can be adjusted using the sliders at the bottom, by sliding the speakers at the top or by direct typed entry. To directly enter the delay time, double click the delay time and type a new value. If you hold down the left mouse button on a slider, you can fine adjust the delay by using the up and down arrow buttons on the keyboard. The delay display units can be selected on the right.



The input sources for each output are routed on the Matrix screen. Click the input button below the output to select. If more than one source is selected those inputs will sum. A graphical representation of the routing is given at the top. Inputs and outputs can also be labeled in this screen.

Input Equalization Edit Screen

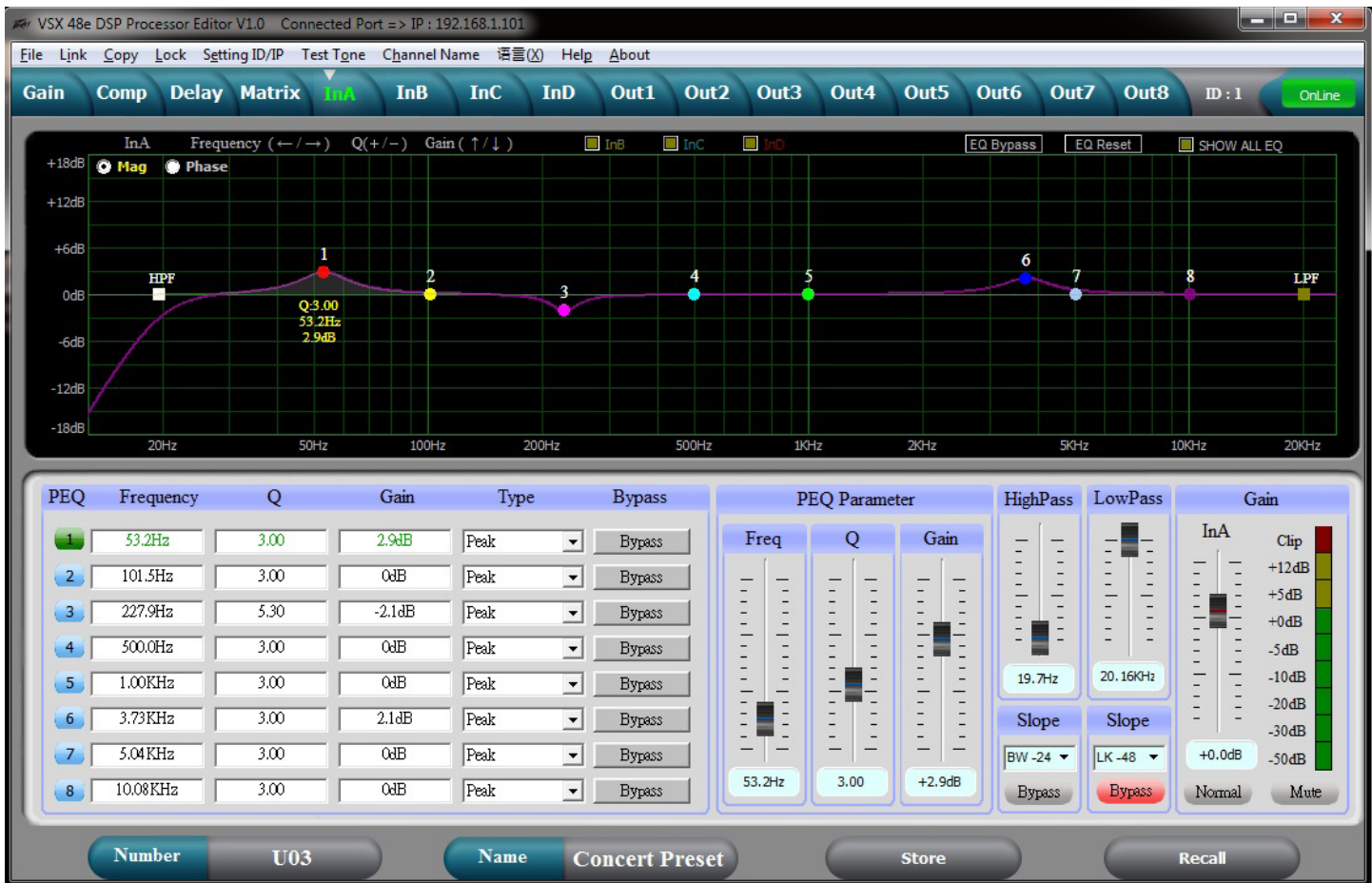

The input equalization can be adjusted using this screen. When you select a PEQ band # at the bottom left of the screen, the parameters for that band can be adjusted using the PEQ Parameter sliders. A PEQ band can also be adjusted by selecting the corresponding band on the graph with the mouse and dragging it to set frequency and amplitude. While holding mouse button down, the Q can be adjusted using the + and - keys. If you double click on a parameter in the PEQ matrix, you can directly type in a new value. The graph can display either the magnitude of filter responses or the resulting phase response. The graph of other inputs can also be overlaid on the screen by clicking boxes on top of the graph.

Output Equalization Edit Screen

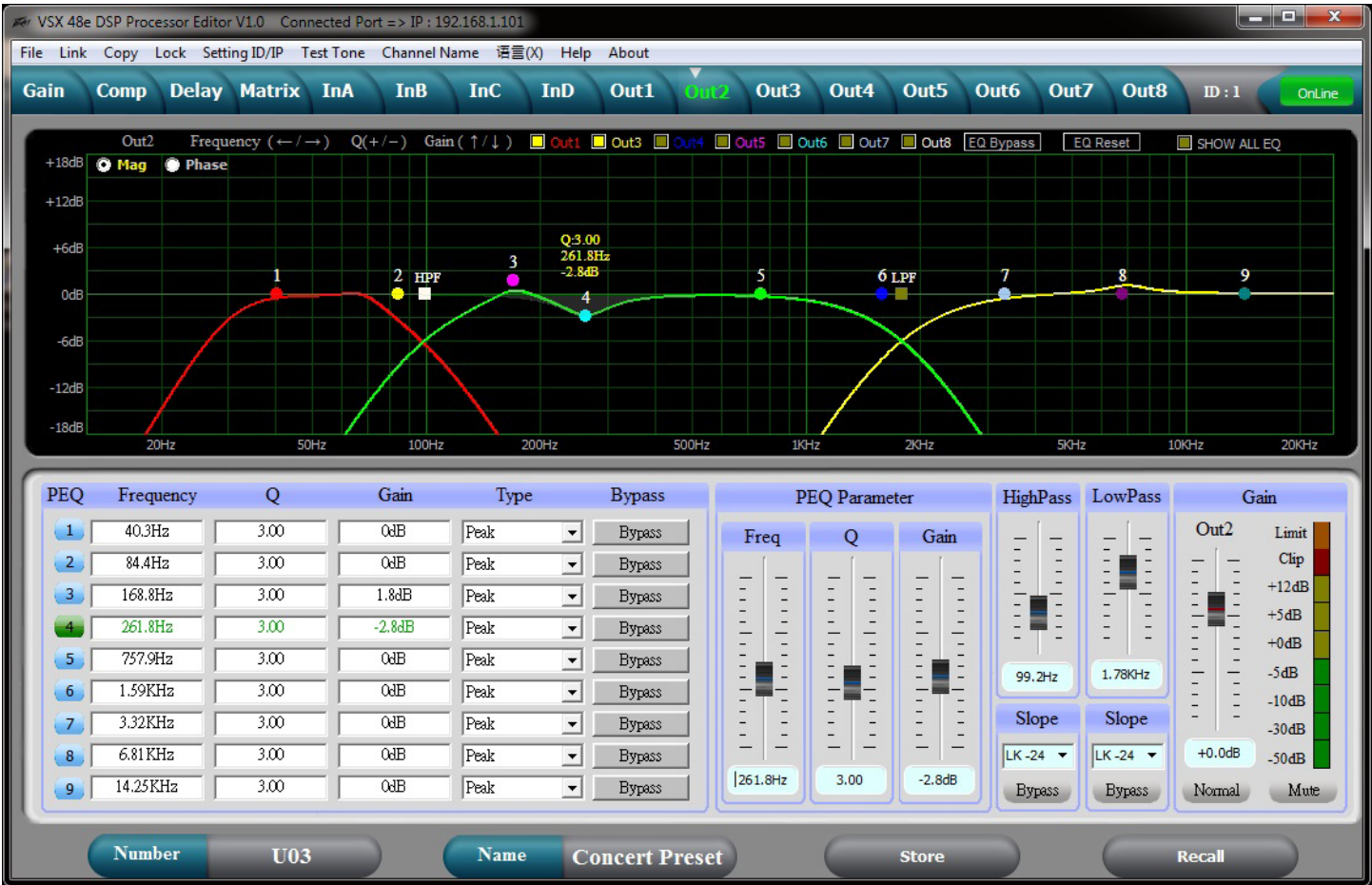

The output equalization can be adjusted using this screen. When you select a PEQ band # at the bottom left of the screen, the parameters for that band can be adjusted using the PEQ Parameter sliders. A PEQ band can also be adjusted by selecting the corresponding band on the graph with the mouse and dragging it to set frequency and amplitude. While holding mouse button down, the Q can be adjusted using the + and - keys. If you double click on a parameter in the PEQ matrix, you can directly type in a new value. The graph can display either the magnitude of filter responses or the resulting phase response. The graph of other outputs can also be overlaid on the screen by clicking boxes on top of the graph.

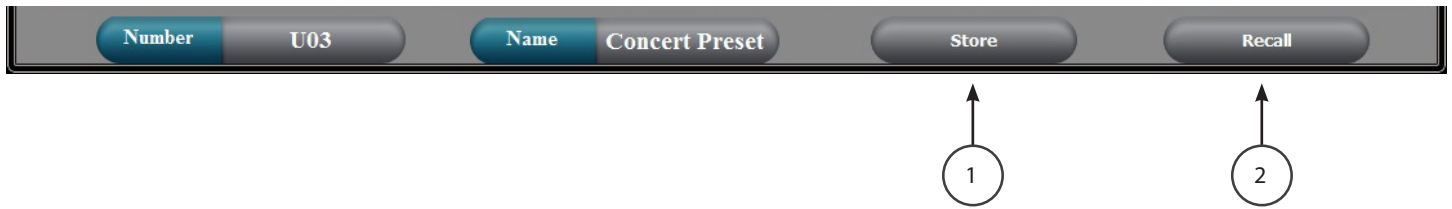

Store (1)

The store button at the bottom of the screen duplicates the store button on the front panel of the VSX. The user can select one of 30 user storage locations to save the current settings.

Recall (2)

The Recall button at the bottom of the screen duplicates the Recall button on the front panel of the VSX. The user can Recall one of 30 user stored presets.

File > Open

Open a saved *.prs "preset" file. If you wish to open a preset (*.prs) file and load it into the VSX, you must be connected and "Online" when you open the file. If the VSX is "offline" it will load only into the editor program. If you then connect the editor to the VSX going 'Online', the VSX settings will be loaded into the editor overwriting the editor settings.

File > Save

Save the current settings in the editor into a *.prs "preset" file.

File > Upload

This uploads all of the presets from the VSX and saves them to a *.unt "unit file.

File > Download

This loads a *.unt file containing all of the unit presets into the connected unit. The VSX will be "offline" when complete.

Specifications

Input Impedance:	20 k Ohms
Output Impedance:	100 Ohms
Frequency response Input to Output:	+0/ -0.5 dB 10 Hz to 21 kHz +0/ -1.0 dB 10 Hz to 32 kHz
Maximum Input level:	+20 dBu
Maximum Output level:	+20 dBu
THD + N @ 1 kHz:	0.007%
Noise floor 22-22kHz	-87 dBu unweighted -89 dB A-Weighted
Dynamic range >	107 dB unweighted 109 dB A-Weighted.
Crosstalk between channels:	Less than -100 dB at 1 kHz.

LED Meter Input:

LED Color	Label	dBu *	dBFS *
Red	Clip	+15	-5
Yellow	+5	+5	-15
Green	0	0	-20
Green	-10	-10	-30
Green	-30	-30	-50

LED Meter Output:

LED Color	Label	dBu *	dBFS *
Amber	Limit	-	-
Red	Clip	+15	-5
Green	0	0	-20
Green	-10	-10	-30
Green	-30	-30	-50

*Note References: 0 dBFS = Maximum signal level before clipping (Full Scale)

0 dBu = 0.775 V rms

Latency analog input to analog output: 3.5 mS

Sample Rate:	96 kHz
Ethernet Interface:	10.0 Mbps
	Static IPv4 address
RS 232 and RS 485:	Baud Rate: 115200
	Data bits: 8
	Parity: None
	Stop bits: 1
RS 232/485 Pinout:	RS 232 RX: Pin 2
	RS 232 TX: Pin 3
	RS 232 GND: Pin 5
	RS 485 +: Pin 7
	RS 485 -: Pin 8
Dimensions:	1.75 x 19 x 8.25 inches H x W x D
	44.5 x 482 x 210 mm
Net Weight:	5.28 pounds 2.39 kg
AC power Input Voltage	195 to 240 VAC 50-60 Hz
Power Consumption	15 Watts
Fuse	F2AL 250V (5x20mm)

RS 232, RS 485 message formats are available in the VSX editor help files.



www.peavey.com

Warranty registration and information for U.S. customers available online at
www.peavey.com/warranty
 or use the QR tag below



Features and specifications subject to change without notice.

Peavey Electronics Corporation 5022 Hartley Peavey Drive Meridian, MS 39305 (601) 483-5365 FAX (601) 486-1278



Logo referenced in Directive 2002/96/EC Annex IV
 (OJ L37/38, 13.02.03 and defined in EN 50419: 2005
 The bar is the symbol for marking of new waste and
 is applied only to equipment manufactured after
 13 August 2005