

BASSO15

15" Bass-Reflex Multipurpose Subwoofer



QuickStart Guide

Many key factors are to be considered when configuring the subwoofer section of a loudspeaker system to perfectly match each application: size/weight, logistic and operational setups, SPL needs, LF extension, cost limitations, as well as sound engineer preferences (depending on different the type and size of the event) or audio program characteristics and regional style taste for subwoofer mixes.

BASSO Series models allow the user to choose the most adequate subwoofer for any given situation from within a family of products with common finish, design solutions and performance philosophy as well as shared rigging and transport accessories.

BASSO15 is a 15" bass-reflex subwoofer with a very compact design and excellent power-density that make this loudspeaker a versatile tool for installed sound reinforcement and portable FOH applications.

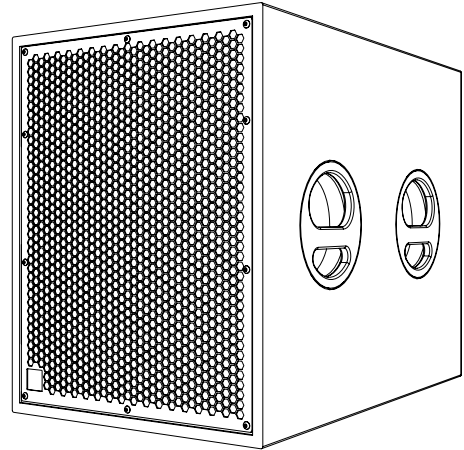

SYSTEM CONFIGURATION AND SETTINGS

BASSO15 back panel is fitted with a pair of Neutrik NL-4 connectors in parallel for straightforward, flexible installation setup.

NL-4 PINOUT:

+/- 1	Subwoofer Signal
+/- 2	Parallel Signal

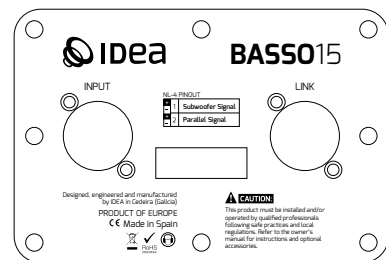



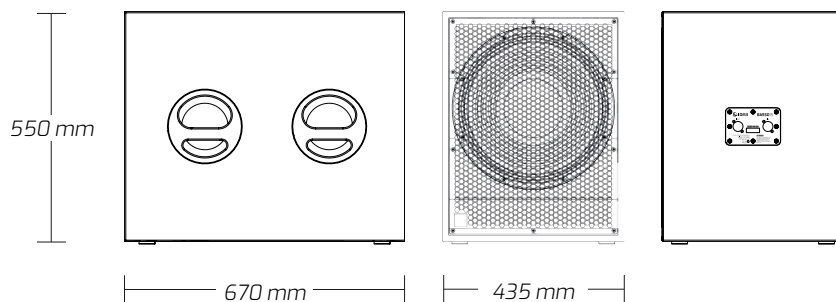

TECHNICAL DATA

Enclosure design	Bass Reflex
Transducers	1 x 15"
Power Handling (RMS)	1 000 W
Nominal Impedance	8 Ohm
SPL (Continuous/Peak)	130/136 dB SPL
Frequency Response (-10 dB)	30 - 100/120/140 Hz
Frequency Range (-3 dB)	36 - 80/100/120 Hz
Dimensions (WxHxD)	435 x 550 x 670 mm (17.1 x 21.7 x 26.4 inch)
Weight	35 kg (77.1 lbs)
Connectors	2 x Neutrik speakOn NL-4 in parallel
+/-1	Input
+/-2	Link
Cabinet Construction	15 mm Plywood
Grille	1.5 mm perforated weatherised steel with protective foam
Finish	Durable IDEA proprietary Aquaforce paint coating process
Handles	2 integrated handles
Feet/Skates	4 rubber feet
Installation	36 mm Pole mount socket
Accessories	35 mm Pole (K&M-21336)

TECHNICAL DRAWINGS



WARNINGS AND SAFETY GUIDELINES

- Read this document thoroughly, follow all safety warnings and keep it for future reference.
-  · The exclamation mark inside a triangle indicates that whatever repairing and component replacement operations must be done by qualified and authorized personnel.
- No user serviceable parts inside.
- Only use accessories tested and approved by IDEA and supplied by the manufacturer or an authorized dealer.
- Installations, rigging and suspension operations must be done by qualified personnel.
- Only use accessories specified by IDEA, complying with maximum loads specifications and following local safety regulations.
-  · Read the specifications and connection instructions before proceeding to connect the system and use only cabling supplied or recommended by IDEA. Connection of the system should be done by qualified personnel.
- Professional sound reinforcement systems can deliver high SPL levels that may result in hearing damage. Do not stand close to the system while in use.
-  · Loudspeaker produce magnetic field even while they are not in use or even when disconnected. Do not place or expose loudspeakers to any device that is sensitive to magnetic fields such as television monitors or data storage magnetic material.
- Disconnect the equipment during lightning storms and when it is not to be used for a long time.
- Do not expose this device to rain or moisture.
- Do not place any objects containing liquids, such as bottles or glasses, on the top of the unit. Do not splash liquids on the unit.
- Clean with a wet cloth. Do not use solvent-based cleaners.
- Regularly check the loudspeaker housings and accessories for visible signs of wear and tear, and replace them when necessary.
- Refer all servicing to qualified service personnel.
-  · This symbol on the product indicates that this product should not be treated as household waste. Follow local regulation for recycling of electronic devices.
- IDEA declines any responsibility from misuse that may result in malfunction or damage of the equipment.

WARRANTY

- All IDEA products are guaranteed against any manufacturing defect for a period of 5 years from date of purchase for acoustical parts and 2 years from date of purchase for electronic devices.
- The guarantee excludes damage from incorrect use of the product.
- Any guarantee repair, replacement and servicing must be exclusively done by the factory or any of authorized service centres.
- Do not open or intend to repair the product; otherwise servicing and replacement will not be applicable for guarantee repair.
- Return the damaged unit, at shipper's risk and freight prepaid, to the nearest service centre with a copy of the purchase invoice in order to claim guarantee service or replacement.

DECLARATION OF CONFORMITY

*I MAS D ELECTROACÚSTICA SL
POL. A TRABE 19-20 15350 CEDEIRA (GALICIA - SPAIN)
DECLARES THAT: BASSO15
COMPLIES WITH THE FOLLOWING EU DIRECTIVES:
ROHS (2002/95/CE) RESTRICTION OF HAZARDOUS SUBSTANCES
LVD (2006/95/CE) LOW VOLTAGE DIRECTIVE
EMC (2004/108/CE) ELECTRO-MAGNETIC COMPATIBILITY
WEEE (2002/96/CE) WASTE OF ELECTRIC AND ELECTRONIC EQUIPMENT
EN 60065: 2002 AUDIO, VIDEO AND SIMILAR ELECTRONIC APPARATUS. SAFETY REQUIREMENTS.
EN 55103-1: 1996 ELECTROMAGNETIC COMPATIBILITY: EMISSION
EN 55103-2: 1996 ELECTROMAGNETIC COMPATIBILITY: IMMUNITY*



www.ideaproaudio.com



For further information scan the QR Code
or refer to the following web address: www.ideaproaudio.com/product-detail/basso15

IDEA is always in pursuit of better performance, greater reliability and design features.
Technical specifications and minor finish details may vary without notice in order to improve our products.

©2020 - I MAS D Electroacústica SL

PoL A Trabe 19-20 15350 Cedeira (Galicia - Spain)