

5" Fixed-Installation Speaker

FEATURES

- Compact unobtrusive design
- Premium European high-efficiency custom IDEA Transducers
- Dedicated wall-mount accessory included
- 16 Ohm (8Ω version available on demand)
- Euroblock connectors
- Rugged 15-mm Birch Plywood construction and finish
- Durable Aquaforce paint, available in standard textured black or white
- Optional RAL colours on demand



APPLICATIONS

- A/V portable and installed sound reinforcement
- FG/BG music reproduction in distributed audio installed solutions
- Commercial and High Power Domestic applications

OVERVIEW

LUA Series models are compact, passive loudspeakers that deliver outstanding sonic definition and versatility that combine professional finish and solid construction with original stylish design and excellent acoustic qualities that are ideal for professional audio playback in mobile, AV and distributed sound installed solutions. Ideal for restaurants, pubs, lounges, museums, ...

LUA loudspeakers are specially indicated for fixed installations and those applications in which acoustical performance and aesthetics are essential, above absolute power delivery and road-readiness.

LUA5i has been designed as a High-Fidelity work-horse for installations of distributed audio that require truly superior BGM reproduction with minimal impact on the aesthetics of the location and truly rugged and solid construction compared to most products in this category.

BR-L5i Included Wall-mount accessory.

LUA5i features a 1" dome tweeter and a high-performance 5" woofer in a front-firing ported trapezoidal cabinet built with 12-mm Birch plywood and durable, high resistant IDEA paint coating. The front side of the loudspeaker is protected by a 1.5-mm weatherized steel grille and a internal protective foam.

Installation of **LUA5i** is a quick, straightforward operation thanks to the included rear wall-mount accessory. Six M6 inserts in the rear side of the cabinet allow for both vertical and horizontal installation with the wall-mount bracket.



TECHNICAL DATA

Enclosure design	Rectangular
HF Transducer	1" Dome Tweeter
LF Transducer	1 x 5" High performance woofer
Power Handling (RMS)	150 W
Nominal Impedance	16 Ohm (8Ω version available on demand)
SPL (Continuous/Peak)	113/119 dB SPL
Frequency Range (-10 dB)	87 - 23000 Hz
Frequency Range (-3 dB)	120 - 180000 Hz
Coverage	70° Axisymmetric
Dimensions (WxHxD)	160 x 303 x 180 mm (6.3 x 11.9 x 7.1 in)
Weight	5.2 kg (11.5 lb)
Connectors	Euroblock
Cabinet Construction	15 mm Birch Plywood
Grille	1.5 mm perforated weatherised steel with protective foam
Finish	Durable IDEA proprietary Aquaforce high-resistance paint coating process
Installation	6 x M6 inserts
Accessories	Wall mount (WM LUA5i)

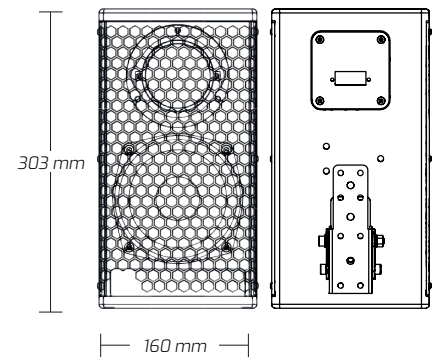
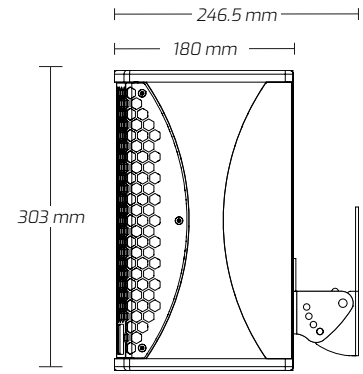

ACOUSTICAL MEASUREMENTS

FREQUENCY RESPONSE

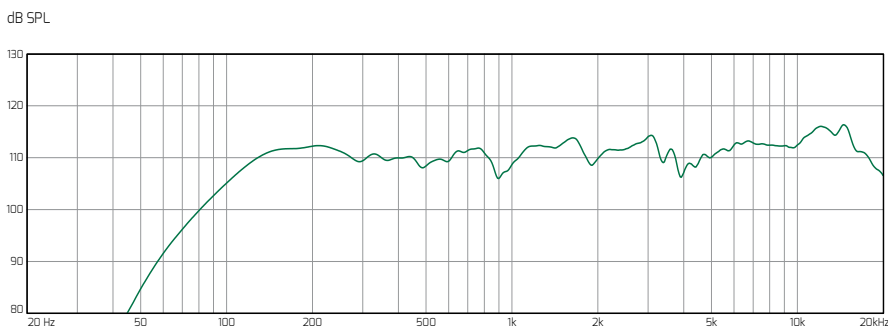

This graph shows the frequency response for a 1-watt swept sine signal in an anechoic environment (4pi), measured at 3 m and scaled down at 1 m.

In order to provide more precise information for acoustical analysis, a 1/12 octave smoothing has been applied.

IMPEDANCE

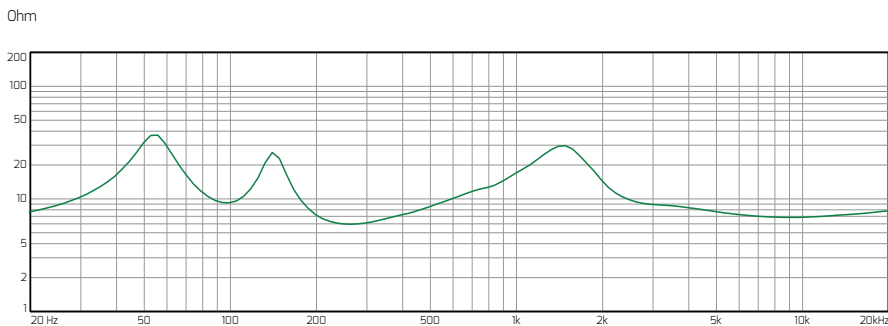

HORIZONTAL 1/3 OCTAVE POLARS

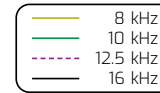
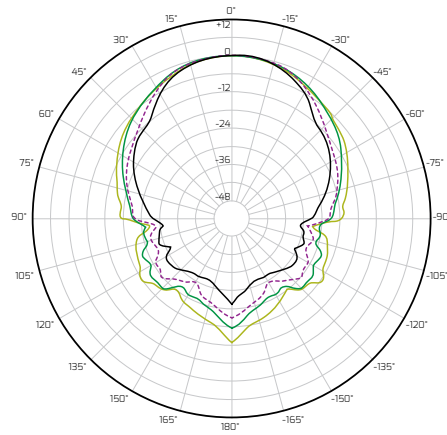
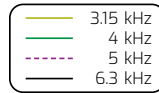
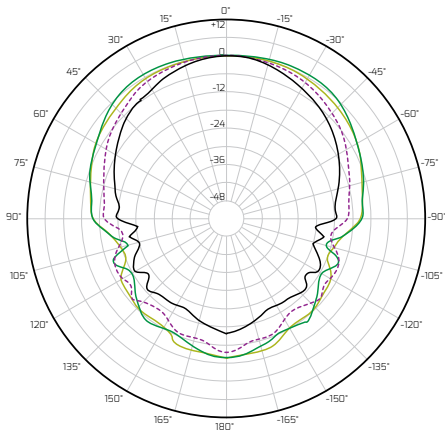
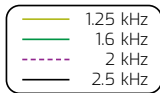
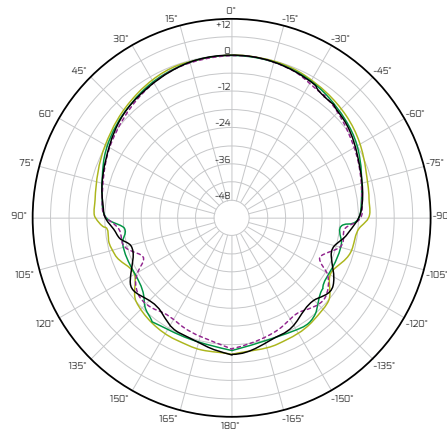
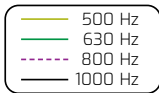
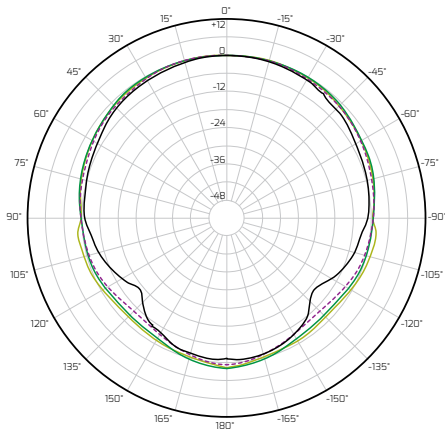
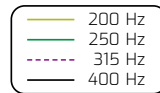
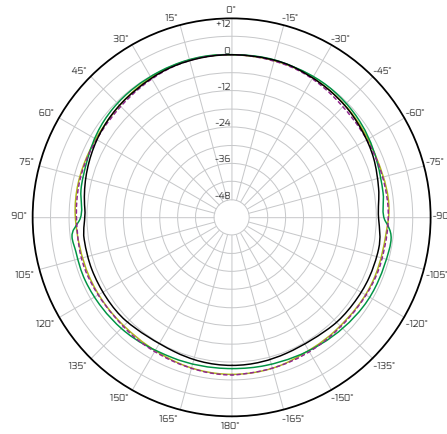
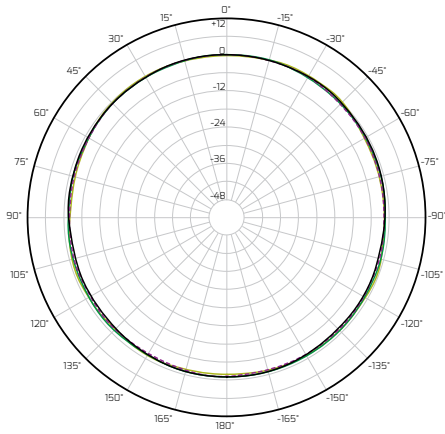

VERTICAL 1/3 OCTAVE POLARS

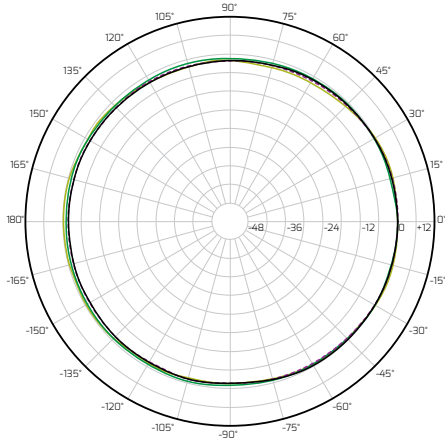

- 80 Hz
- 100 Hz
- - - 125 Hz
- 160 Hz

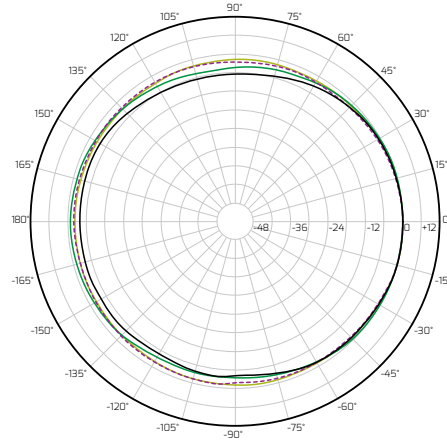

- 200 Hz
- 250 Hz
- - - 315 Hz
- 400 Hz

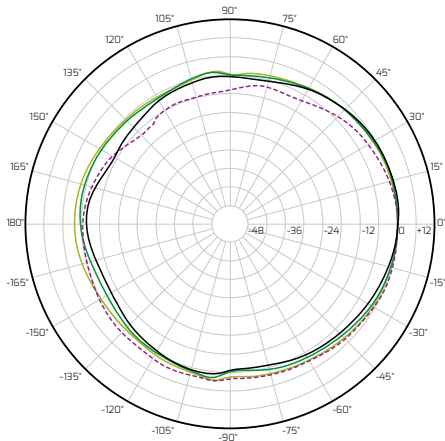

- 500 Hz
- 630 Hz
- - - 800 Hz
- 1000 Hz

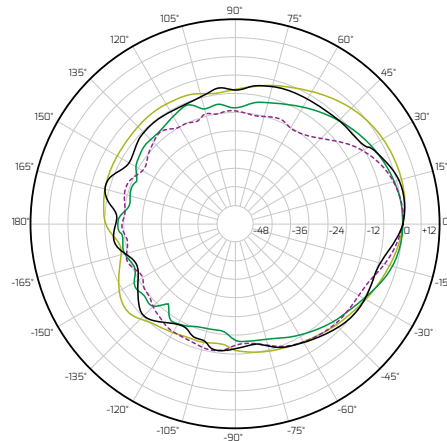

- 1.25 kHz
- 1.6 kHz
- - - 2 kHz
- 2.5 kHz

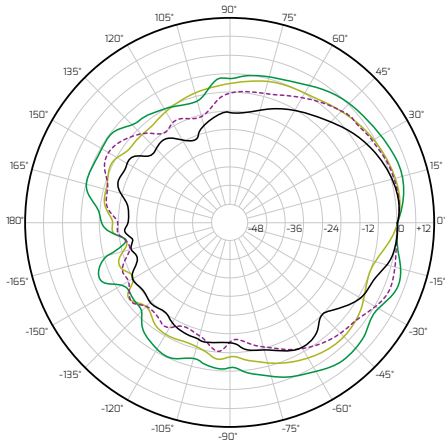

- 3.15 kHz
- 4 kHz
- - - 5 kHz
- 6.3 kHz

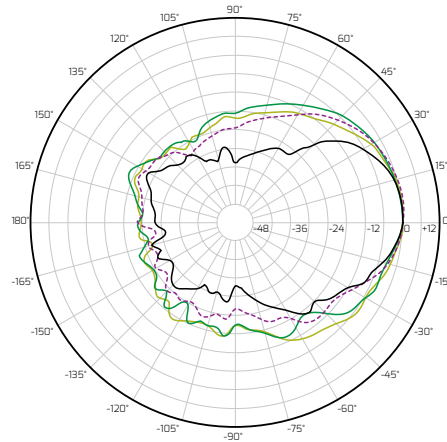

- 8 kHz
- 10 kHz
- - - 12.5 kHz
- 16 kHz