

EXO66

Passive Multipurpose High-Output Mini Monitor



Quick Start Guide

EXO66 is a compact multipurpose passive mini monitor conceived for those applications in which high power-density with superior quality audio reproduction and optimum, unobtrusive integration are required.

The design goal of **EXO66** is to tightly package the SPL of standard 10" in a cabinet compact enough to be easily transported in mobile and portable sound reinforcement applications and to be discreet and elegant in any installation project (RAL colors available on demand), while using the same materials and finish that are found in the Touring Sound larger loudspeaker systems of the IDEA product portfolio.

EXO66 features a 6.5" Coaxial and a high performance 6.5" woofer, in a very tight, compact rear-ported cabinet. This configuration delivers pristine audio clarity at any level with minimum distortion, making the **EXO66** a pleasure to listen to, due to the excellent definition of the HF section and the natural fast and controlled transient response of the custom 6.5" IDEA LF woofers, which are some of the most powerful transducers of its kind available in the market today.

Together with **BASSO24t** or **BASSO18**, **EXO66** will turn into a really versatile, powerful multipurpose combo for a variety of applications. Entertainers, musicians and DJs benefit from the advantages of such power-density, as much as AV rental companies, just like premium installations and AV/Multimedia facilities find an excellent choice for superior audio reproduction in the tiny, refined and powerful **EXO66**.

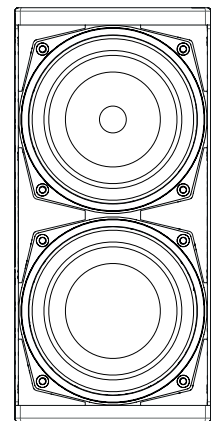
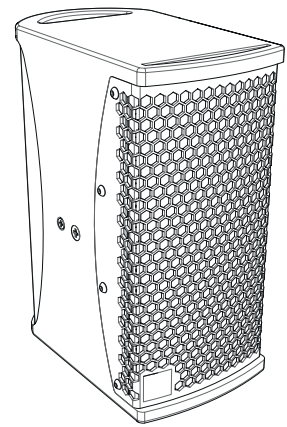

INSTALLATION ACCESSORIES

EXO66 is fitted with threaded M8 inserts for hung permanent installations with UB-E66 accessories as well as a bottom 36 mm pole-mount socket that serves for both pole mount configurations onto a **BASSO** Series subwoofer.

Optional Wall-Mount Accessories

The optional U-Bracket accessories for **EXO66** allows for different wall-mount options and precise vertical angulations. Fit the M8 bolts, choose the proper vertical angle and lock the position with a M6 bolt per side.

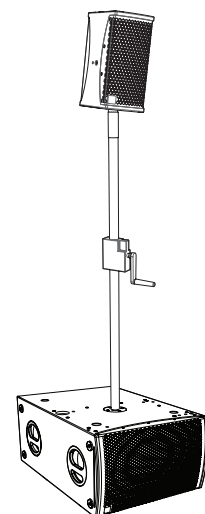
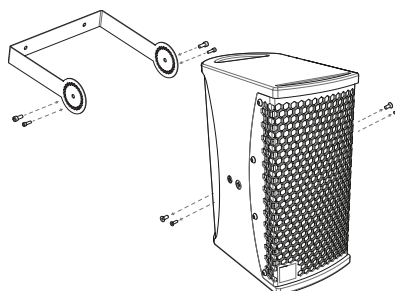

Together with **BASSO24t**, **EXO66** will turn into a really versatile, powerful multipurpose combo with a compact form-factor and stylish design.

TECHNICAL DATA

Enclosure design	Rectangular
Transducer configuration	High Power 6.5" woofer High Power 6.5" + 1.75" Coaxial Compression Driver
Power Handling (RMS)	400 W
Nominal Impedance	8 Ohm
SPL (Continuous/Peak)	121/127 dB SPL
Frequency Range (-10 dB)	95 - 19000 Hz
Frequency Range (-3 dB)	135 - 15000 Hz
Coverage	75°/75° (H/V)
Dimensions (WxHxD)	170 x 365 x 330 mm (6.7 x 14.4 x 13 in)
Weight	12.9 Kg (28.4 lb)
Connectors	2 x Neutrik speakOn NL-4 in parallel
+/-1	Input
+/-2	Link
Cabinet Construction	15 mm Birch Plywood
Grille	1.5 mm weatherised steel with protective foam
Finish	Durable high resistance paint coating process
Handles	2 integrated handles
Installation	Bottom 36 mm pole mount socket
Accessories	U-bracket vertical (UB-E66-V) U-bracket horizontal (UB-E66-H) Pole (K&M-21336)



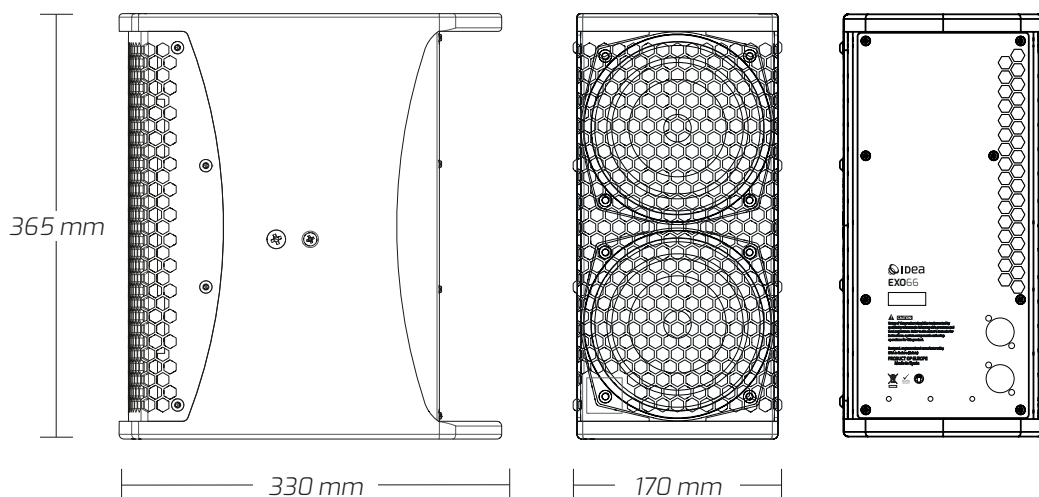

* IEC filtered pink noise with a 6dB crest factor, 2 hours.

** Frequency range values for recommended factory presets.

TECHNICAL DRAWINGS



WARNINGS AND SAFETY GUIDELINES

- Read this document thoroughly, follow all safety warnings and keep it for future reference.
-  · The exclamation mark inside a triangle indicates that whatever repairing and component replacement operations must be done by qualified and authorized personnel.
- No user serviceable parts inside.
- Only use accessories tested and approved by IDEA and supplied by the manufacturer or an authorized dealer.
- Installations, rigging and suspension operations must be done by qualified personnel.
- Only use accessories specified by IDEA, complying with maximum loads specifications and following local safety regulations.
-  · Read the specifications and connection instructions before proceeding to connect the system and use only cabling supplied or recommended by IDEA. Connection of the system should be done by qualified personnel.
- Professional sound reinforcement systems can deliver high SPL levels that may result in hearing damage. Do not stand close to the system while in use.
-  · Loudspeaker produce magnetic field even while they are not in use or even when disconnected. Do not place or expose loudspeakers to any device that is sensitive to magnetic fields such as television monitors or data storage magnetic material.
- Disconnect the equipment during lightning storms and when it is not to be used for a long time.
- Do not expose this device to rain or moisture.
- Do not place any objects containing liquids, such as bottles or glasses, on the top of the unit. Do not splash liquids on the unit.
- Clean with a wet cloth. Do not use solvent-based cleaners.
- Regularly check the loudspeaker housings and accessories for visible signs of wear and tear, and replace them when necessary.
- Refer all servicing to qualified service personnel.
-  · This symbol on the product indicates that this product should not be treated as household waste. Follow local regulation for recycling of electronic devices.
- IDEA declines any responsibility from misuse that may result in malfunction or damage of the equipment.

WARRANTY

- All IDEA products are guaranteed against any manufacturing defect for a period of 5 years from date of purchase for acoustical parts and 2 years from date of purchase for electronic devices.
- The guarantee excludes damage from incorrect use of the product.
- Any guarantee repair, replacement and servicing must be exclusively done by the factory or any of authorized service centres.
- Do not open or intend to repair the product; otherwise servicing and replacement will not be applicable for guarantee repair.
- Return the damaged unit, at shipper's risk and freight prepaid, to the nearest service centre with a copy of the purchase invoice in order to claim guarantee service or replacement.

DECLARATION OF CONFORMITY

I MAS D ELECTROACÚSTICA SL
POL. A TRABE 19-20 15350 CEDEIRA (GALICIA - SPAIN)
DECLARES THAT: EX066
COMPLIES WITH THE FOLLOWING EU DIRECTIVES:
ROHS (2002/95/CE) RESTRICTION OF HAZARDOUS SUBSTANCES
LVD (2006/95/CE) LOW VOLTAGE DIRECTIVE
EMC (2004/108/CE) ELECTRO-MAGNETIC COMPATIBILITY
WEEE (2002/96/CE) WASTE OF ELECTRIC AND ELECTRONIC EQUIPMENT
EN 60065: 2002 AUDIO, VIDEO AND SIMILAR ELECTRONIC APPARATUS. SAFETY RE-
QUIREMENTS.
EN 55103-1: 1996 ELECTROMAGNETIC COMPATIBILITY: EMISSION
EN 55103-2: 1996 ELECTROMAGNETIC COMPATIBILITY: IMMUNITY



www.ideaproaudio.com



For further information scan the QR Code
or refer to the following web address: www.ideaproaudio.com/product-detail/exo66

IDEA is always in pursuit of better performance, greater reliability and design features.
Technical specifications and minor finish details may vary without notice in order to improve our products.

©2019 - I MAS D Electroacústica SL

PoL A Trabe 19-20 15350 Cedeira (Galicia - Spain)